

FEATURES

- 640 mA KNX power supply with 29 VDC auxiliary output
- 110-240 VAC 50/60 Hz power input
- Nominal output current: 640 mA (KNX+Aux)
- Power generation for the KNX system (with LED indicator)
- Short-circuit and overvoltage protection
- Reset button and overload status LED
- KNX coil included
- Dimensions 67 x 90 x 79 mm (4.5 DIN units)
- DIN rail mounting (IEC 60715 TH35), with fixing clamp
- Conformity with the CE, UKCA and RCM directives (marks on the right side)

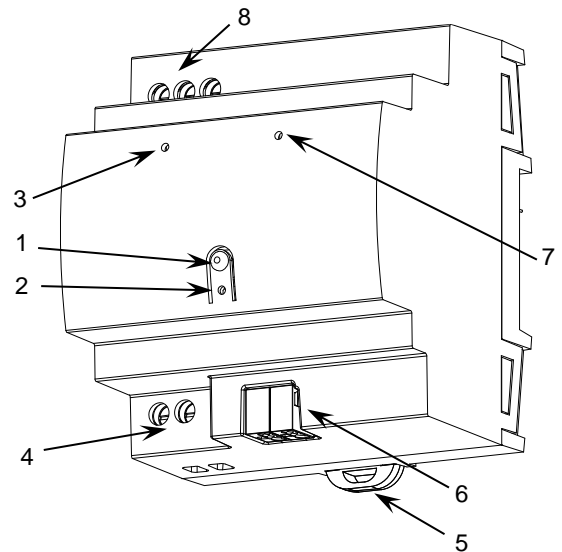

Figure 1: KUPSupply 640mA

1. Reset button	2. Reset status LED	3. Power supply status LED	4. Auxiliary power output
5. Fixing clamp	6. KNX connector	7. Overload status LED	8. Main power supply

RESET BUTTON: long press to completely reset the bus and auxiliary power output. It is recommended to hold it for at least 5 seconds to verify the reset of all the devices in the line.

RESET STATUS LED: it indicates that a reset of the KNX system has been performed by using the corresponding reset button (red blinking). The reset LED will blink slightly in red while the Reset button is pressed.

POWER SUPPLY STATUS LED: it indicates the status of the power supply (green color: the device is working properly; LED off: power supply failure; green blinking: short-circuit on KNX bus and/or auxiliary power output).

OVERLOAD STATUS LED: it indicates an overload on the KNX line or on the auxiliary power output (red color: overload on bus and/or auxiliary power output line; red blinking: cut-off due to overload/short circuit on the KNX bus and/or the auxiliary power output)*.

*Reduce the load on the bus and/or the auxiliary power output lines until its total consumption does not exceed the maximum current specified.

GENERAL SPECIFICATIONS

CONCEPT		DESCRIPTION
Type of device		Electric operation control device
External power supply	Voltage	110-240 VAC 50/60 Hz PF=0.5
	Maximum consumption	400 mA @ 110 VAC / 225 mA @ 230 VAC
	Power Factor	0.5
KNX supply	Voltage (typical)	29 VDC SELV (with KNX coil)
	Maximum rated current (I _{BUS})	640 mA
	Connection type	Typical TP1 bus connector for 0.8 mm Ø rigid cable
Operation temperature		-5 .. +45 °C
Storage temperature		-20 .. +55 °C
Operation humidity		5 .. 95%
Storage humidity		5 .. 95%
Protection class / Overvoltage category		II / III (4200 V)
Operation type		Continuous operation
Device action type		Type 1
Electrical stress period		Long
Complementary characteristics		Class B
Degree of protection		IP20
Installation		Independent device to be mounted inside electrical panels with DIN rail (IEC 60715)
Minimum clearances		Not required
Power failure back-up time		100 ms
Maximum current before overload notification		870 mA
Operation indicator		See previous section
Weight		274 g
PCB CTI index		175 V
Housing material		PC FR V0 halogen free

EXTERNAL POWER SUPPLY SPECIFICATIONS AND CONNECTIONS		
CONCEPT	DESCRIPTION	
Power supply protection fuse	Voltage	110-240 VAC 50/60 Hz
	Current	10 A
	Response type	F (Fast acting)
Connection method	Screw terminal block (0.5 Nm max.)	
Cable cross-section	1.5-4 mm ² (IEC) / 26-10 AWG (UL)	

AUXILIARY POWER OUTPUT SPECIFICATIONS AND CONNECTIONS	
CONCEPT	DESCRIPTION
Voltage (typical)	29VDC SELV
Maximum rated current (I _{AUX})	I _{AUX} + I _{BUS} ≤ 640mA
Connection method	Screw terminal block (0.5 Nm max.)
Cable cross-section	1.5-4 mm ² (IEC) / 26-10 AWG (UL)

INSTALLATION AND CONNECTION

- This KNX power supply unit must be exclusively installed in a 35mm DIN rail inside a distribution box or an electrical panel.
- Ensure suitable ventilation to prevent the temperature from exceeding the permissible range.
- Main power must be connected to L, N and ground terminals.
- Both the coil-integrated KNX bus output and the auxiliary power output must be connected according to the polarity marked on the housing.
- Two power supply units may work in parallel as long as none of them shows overload. In such case, the position on the KNX bus should be modified until the error disappears.

Attaching KUPSupply 640mA to DIN rail:

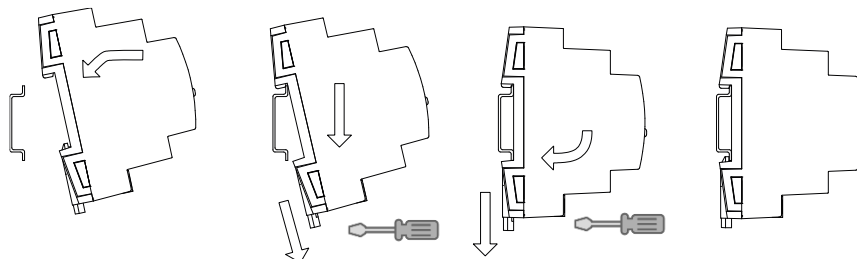

Removing KUPSupply 640mA from DIN rail:

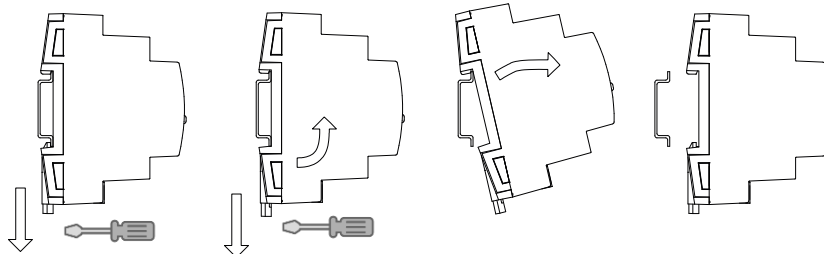

SAFETY INSTRUCTIONS AND ADDITIONAL NOTES

- Installation should only be performed by qualified professionals according to the laws and regulations applicable in each country.
- Do not connect the mains voltage nor any other external voltage to any point of the KNX bus; it would represent a risk for the entire KNX system. The facility must have enough insulation between the mains (or auxiliary) voltage and the KNX bus or the wires of other accessories, in case of being installed.
- The facility must be equipped with a device that ensures the omnipolar sectioning. Installation of a 10 A mini-circuit-breaker is recommended. To prevent accidents, it must remain open in case of manipulation of the device.
- The device has a short-circuit protection fuse that, in case of activation, should only be rearmed or replaced by the Zennio technical service.
- This device contains a security short-circuit proof transformer.
- Once the device is installed (in the panel or box), it must not be accessible from outside.
- For indoor use only.
- Keep the device away from water (condensation over the device included) and do not cover it with clothes, paper or any other material while in use.
-  The WEEE logo means that this device contains electronic parts and it must be properly disposed of by following the instructions at <https://www.zennio.com/en/legal/weee-regulation>.